

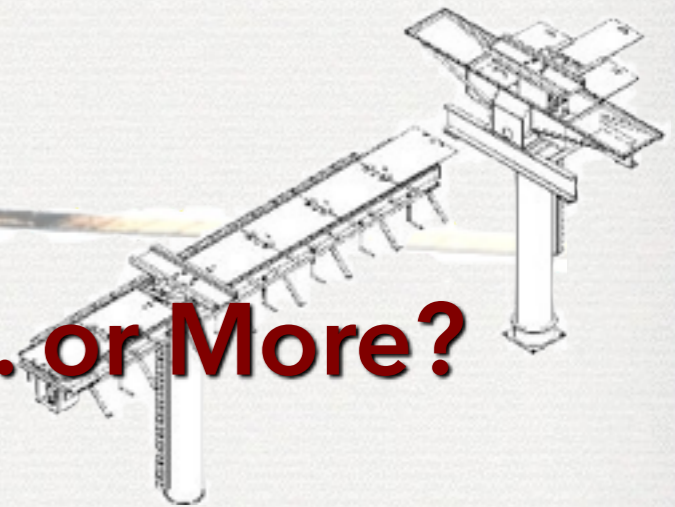

# North American Made Low Pressure In Ground Lifts



**Remember When Lifts Lasted 25 yrs. or More?**





**Recessed Frame 50,000 lb.  
or 72,000 lb. Capacity**

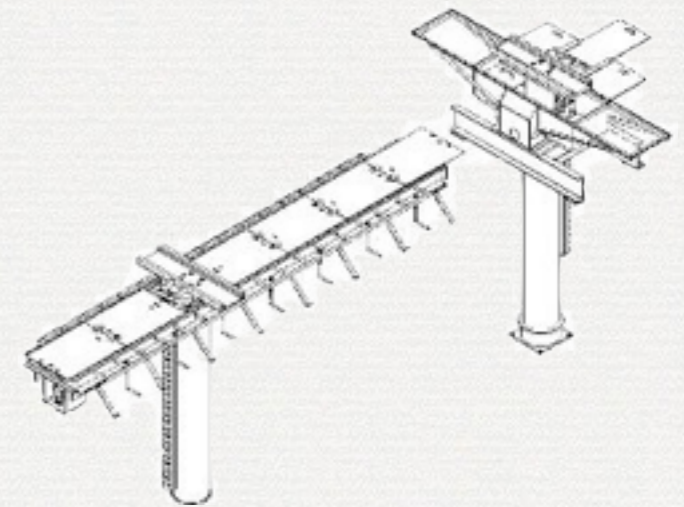

**Remember When Lifts Lasted 25 yrs. or More?**



## KAR Lift Low Pressure HD Lifts

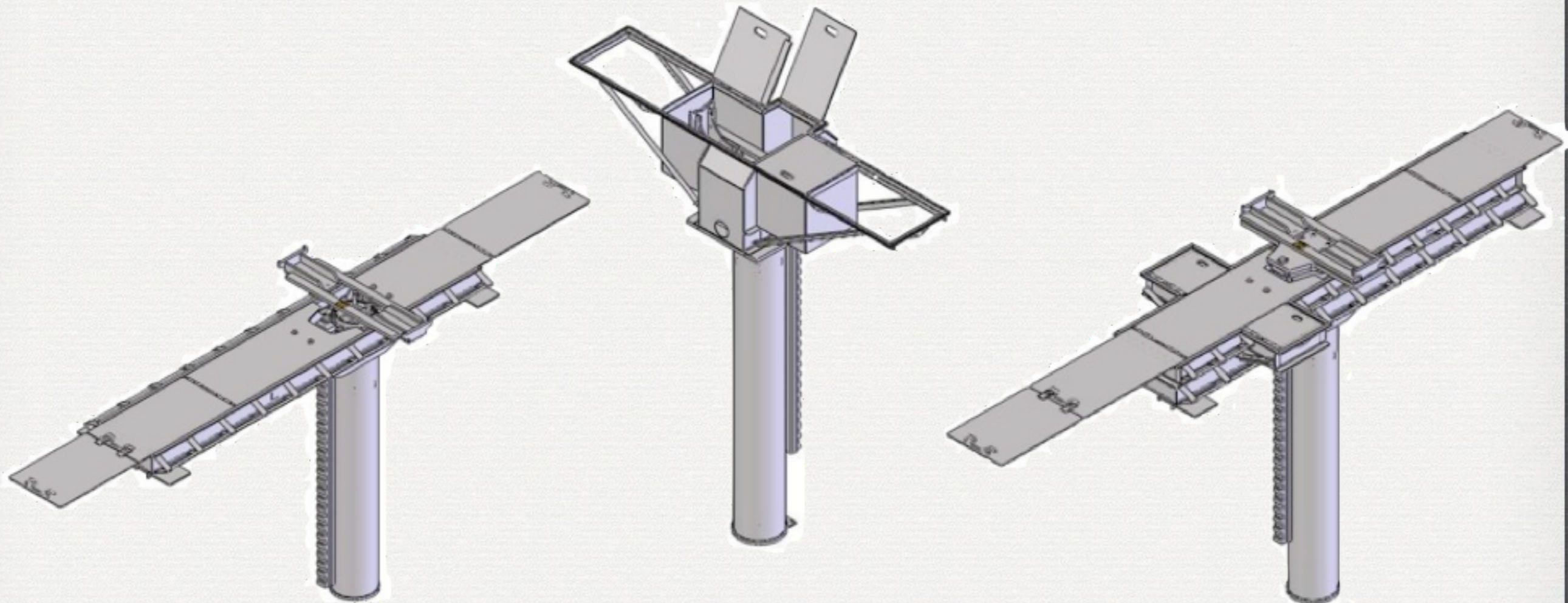

**Remember When Lifts Lasted 25 yrs. or More?**



# Recessed Frame 72,000 lb. Capacity

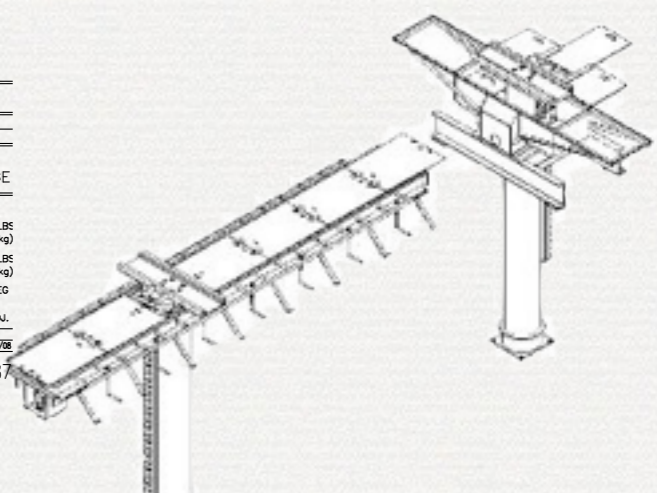
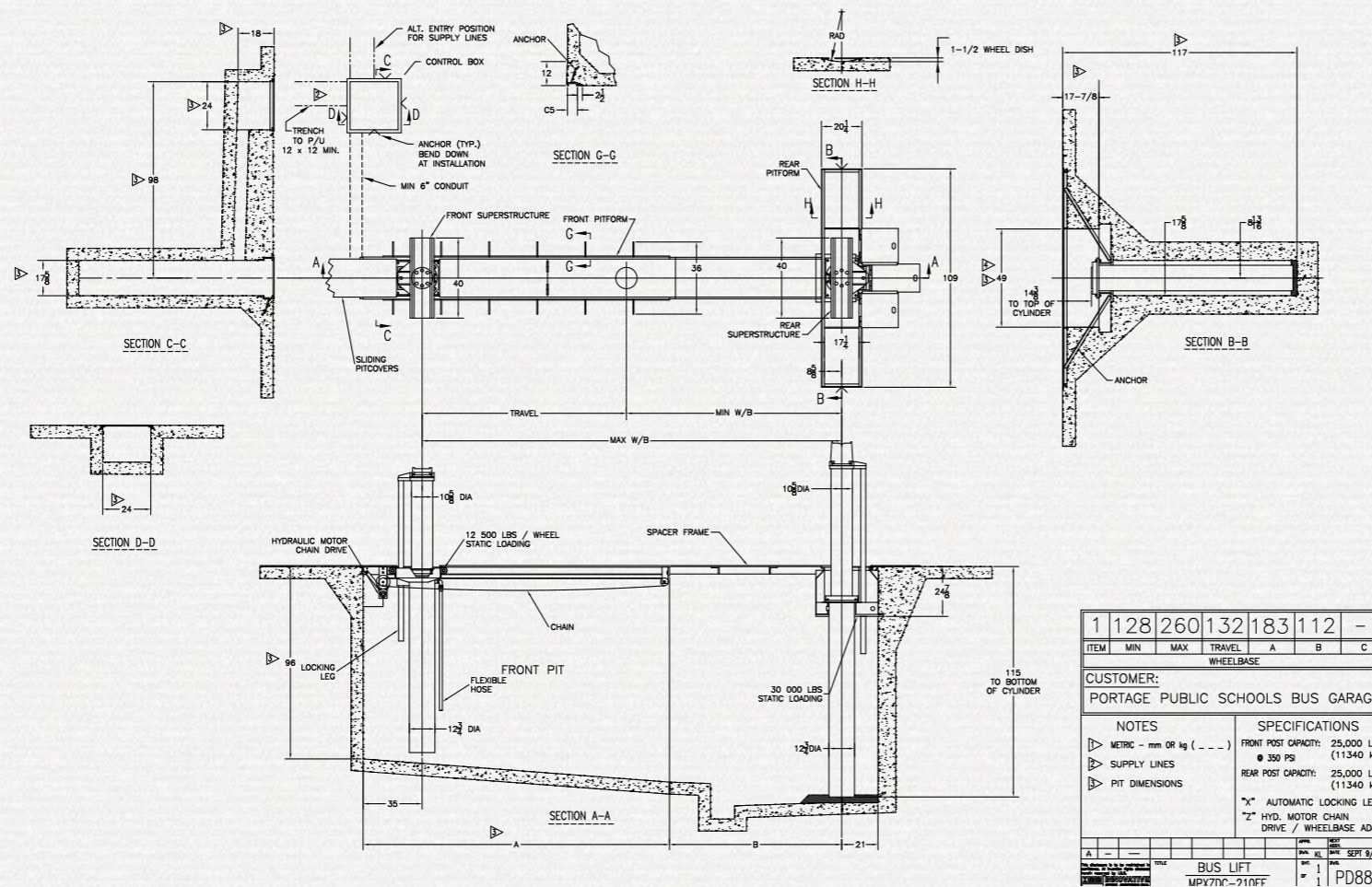

Remember When Lifts Lasted 25 yrs. or More?



## Electronic Panel Control



**Remember When Lifts Lasted 25 yrs. or More?**

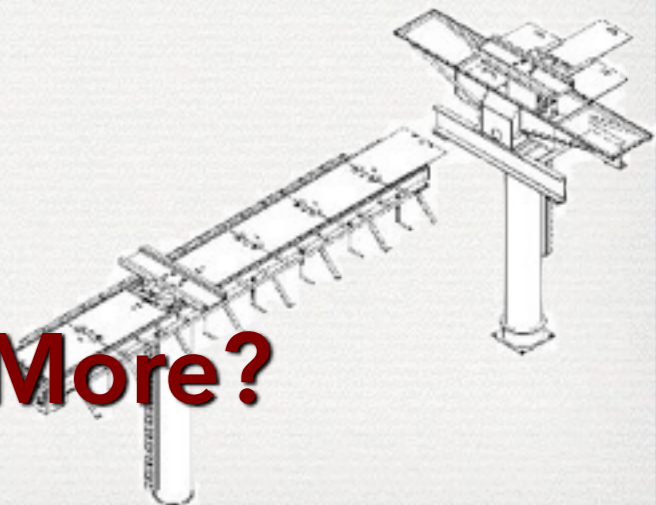



## Remote Pendant Control



**Remember When Lifts Lasted 25 yrs. or More?**





## Pump, Oil Tank & Control

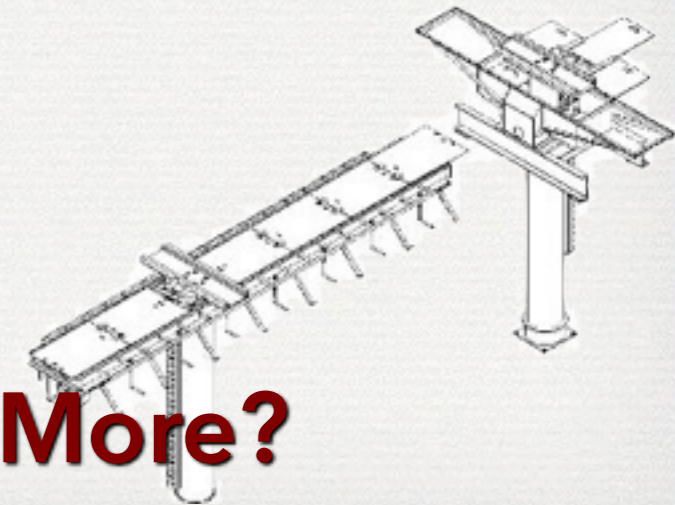

**Remember When Lifts Lasted 25 yrs. or More?**



# Cylinder Plunger with 2" Flange

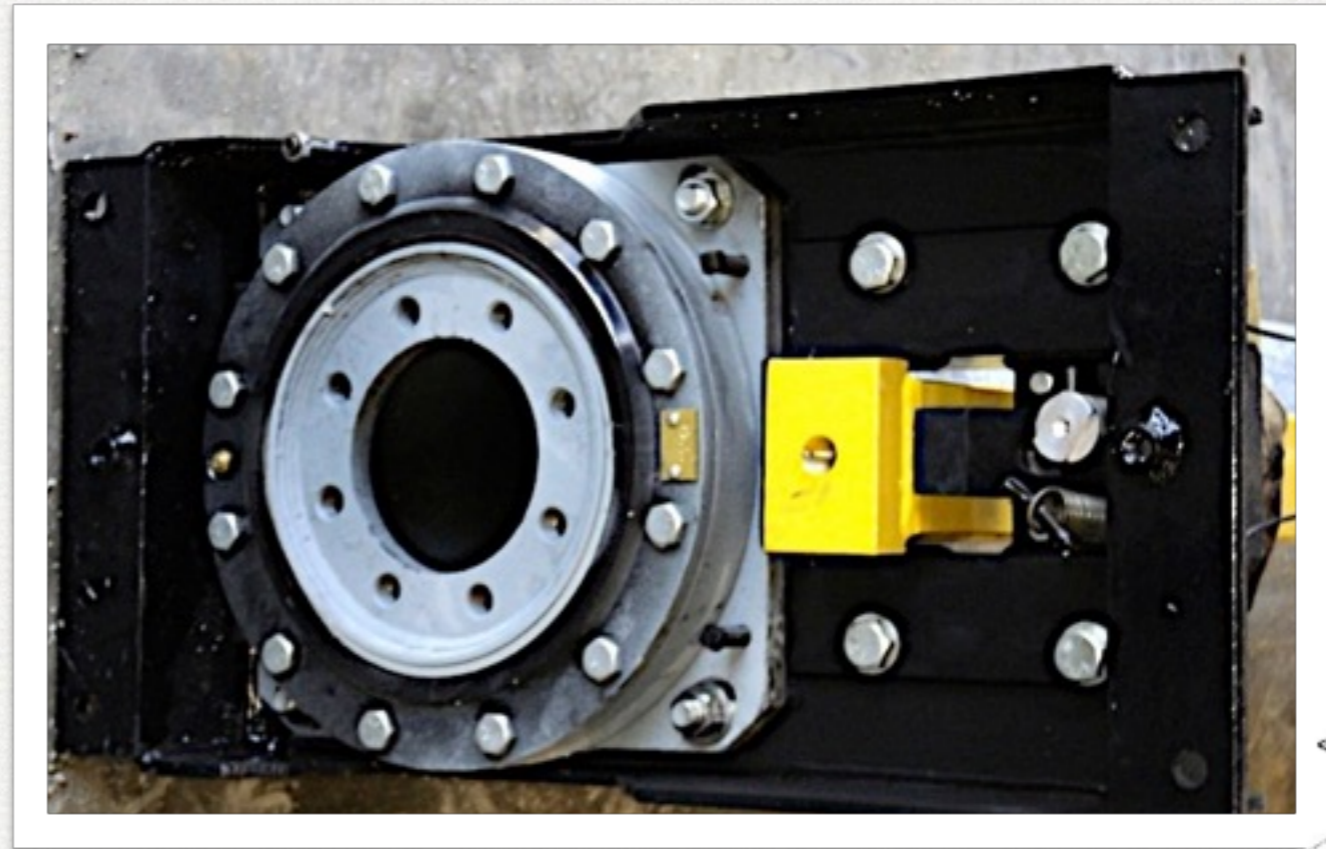

**Remember When Lifts Lasted 25 yrs. or More?**







## Twin Rear Rams - Galvanized

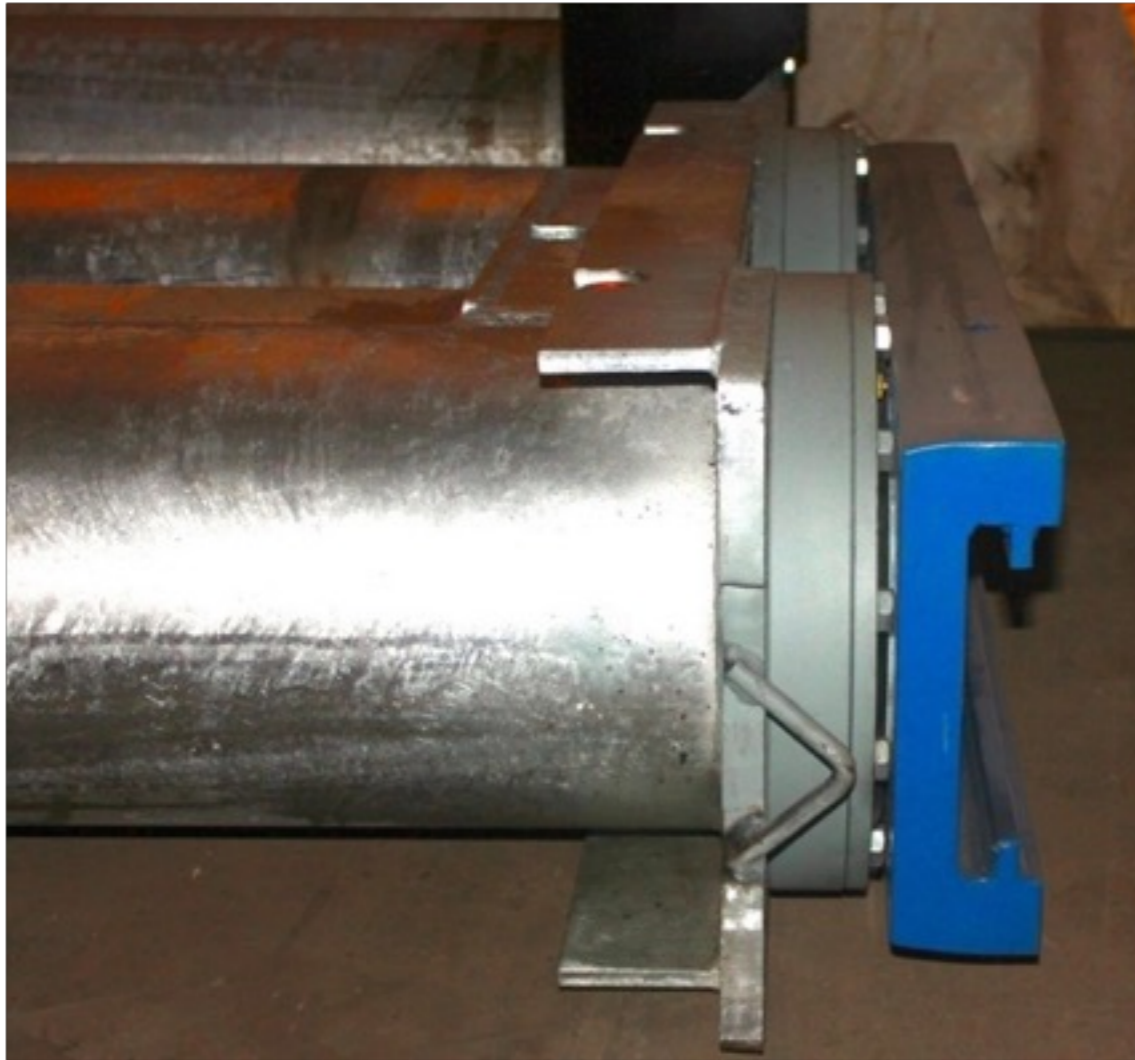

**Remember When Lifts Lasted 25 yrs. or More?**





**Recessed Frame 50,000 lb.  
or 72,000 lb. Capacity**

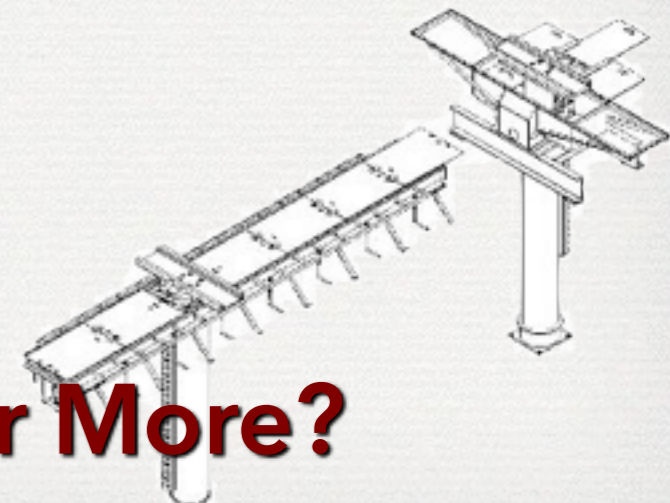

**Remember When Lifts Lasted 25 yrs. or More?**



## Hydraulic Spotter Drive

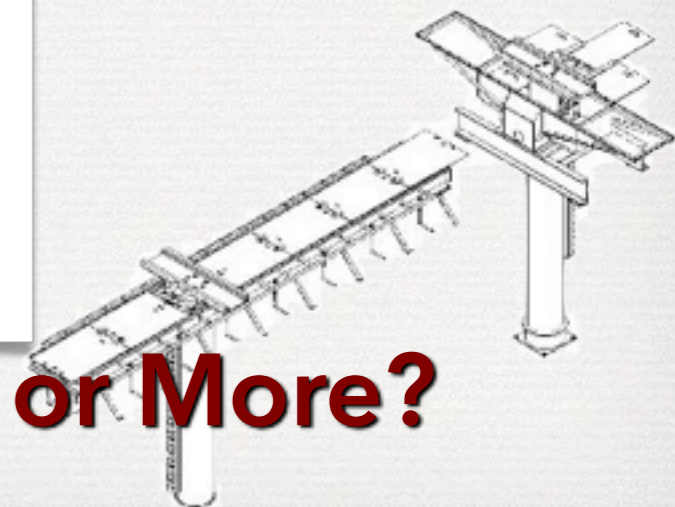
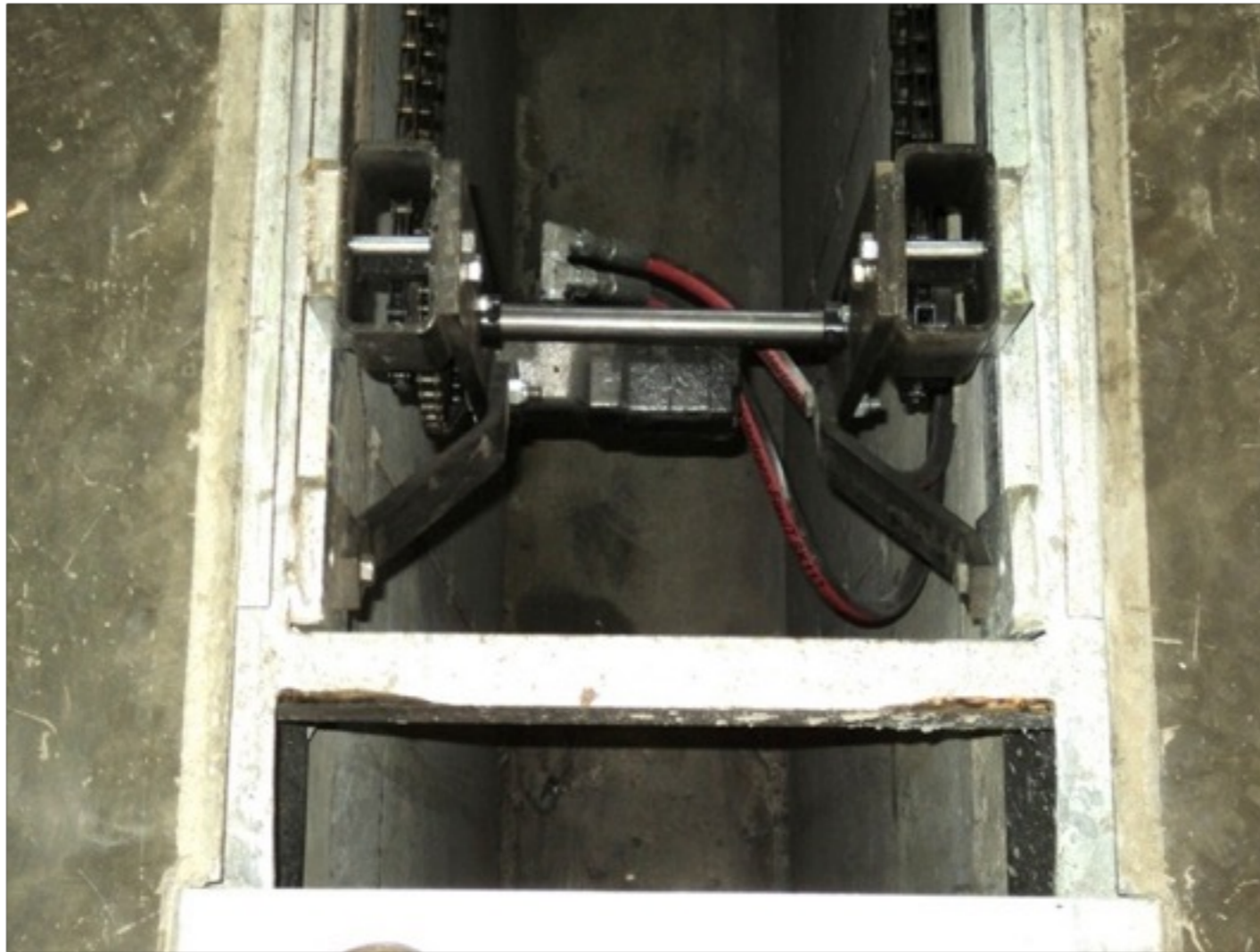

**Remember When Lifts Lasted 25 yrs. or More?**



# Galvanized Track - Roller Bearing

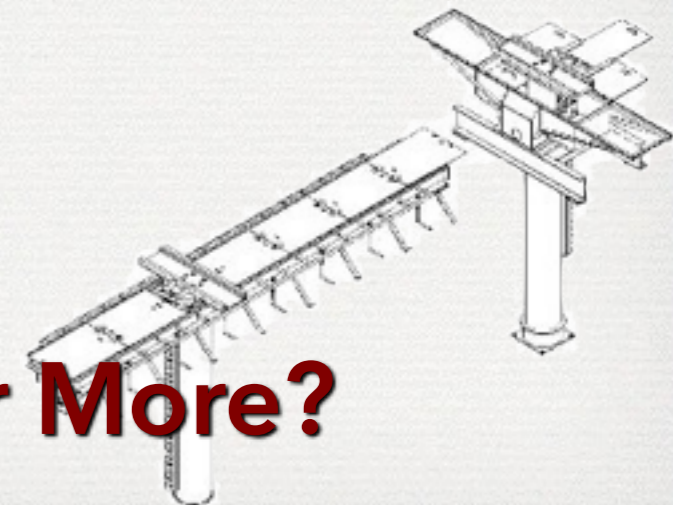

**Remember When Lifts Lasted 25 yrs. or More?**



## Twin Chain Hydraulic Drive

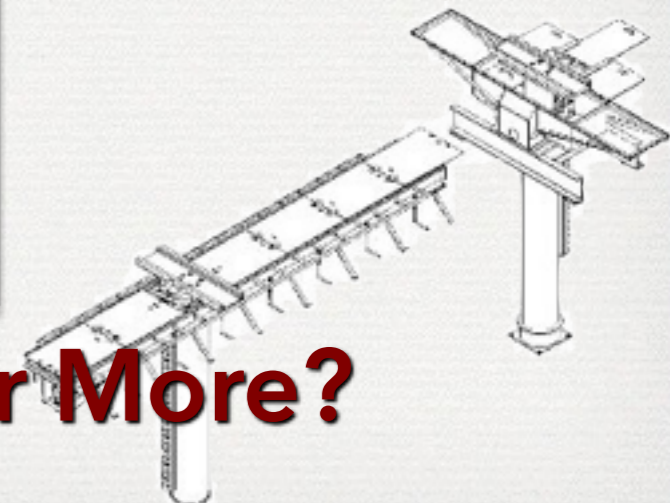

**Remember When Lifts Lasted 25 yrs. or More?**



## Recessed Rear 25,000 lb. Cylinder

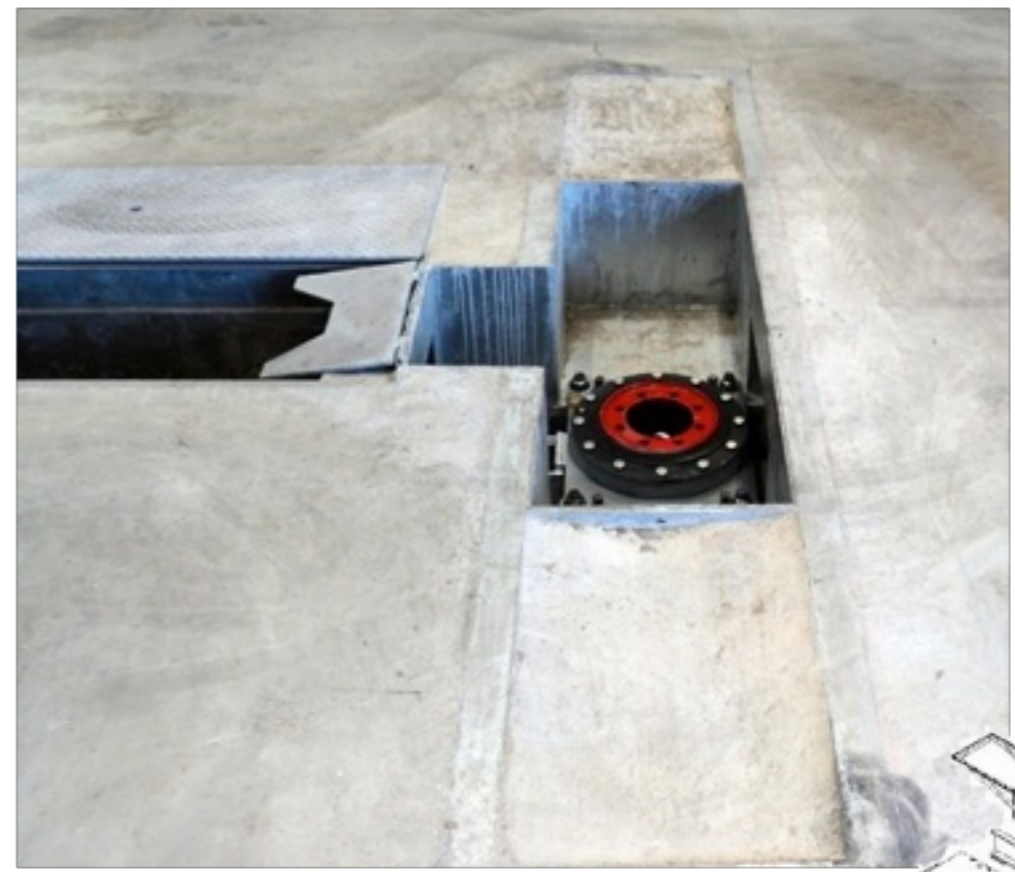
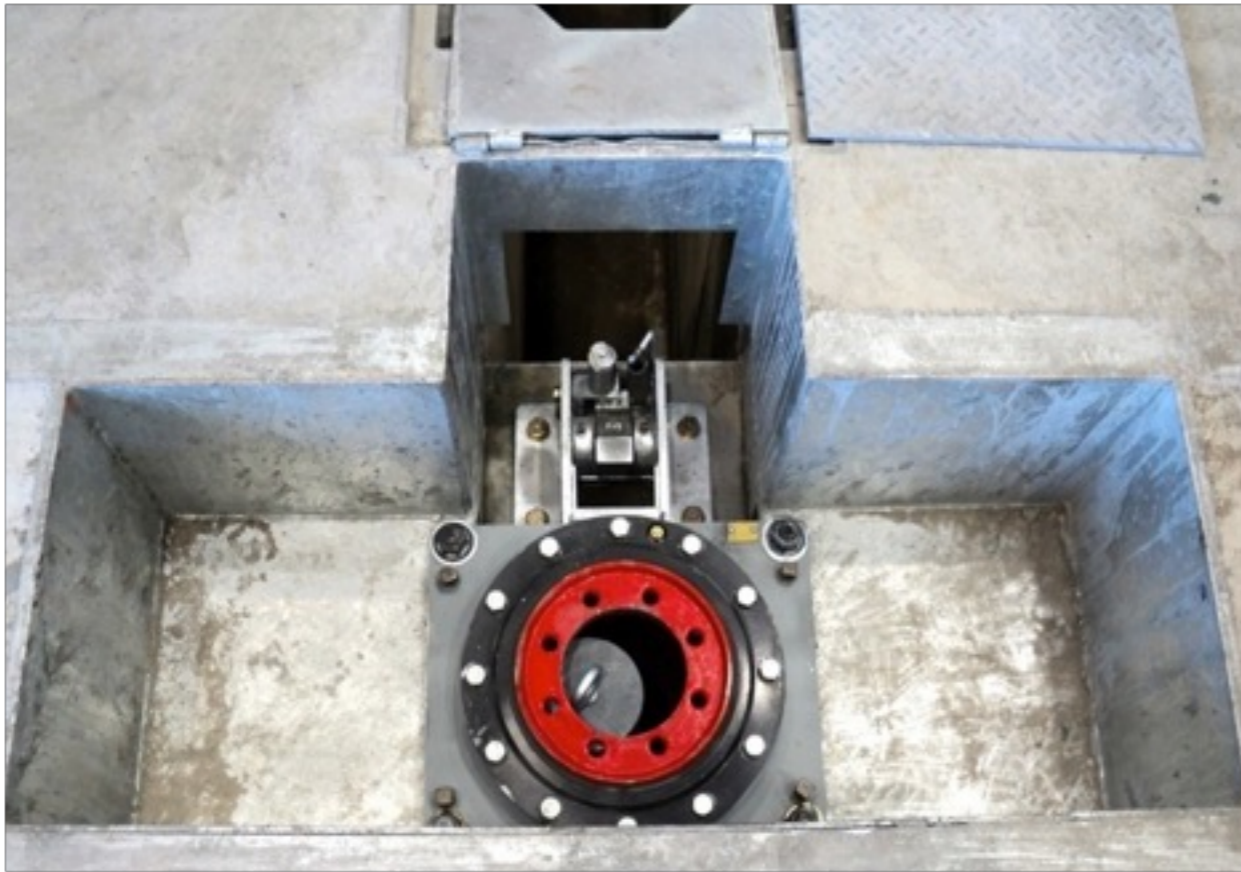

**Remember When Lifts Lasted 25 yrs. or More?**

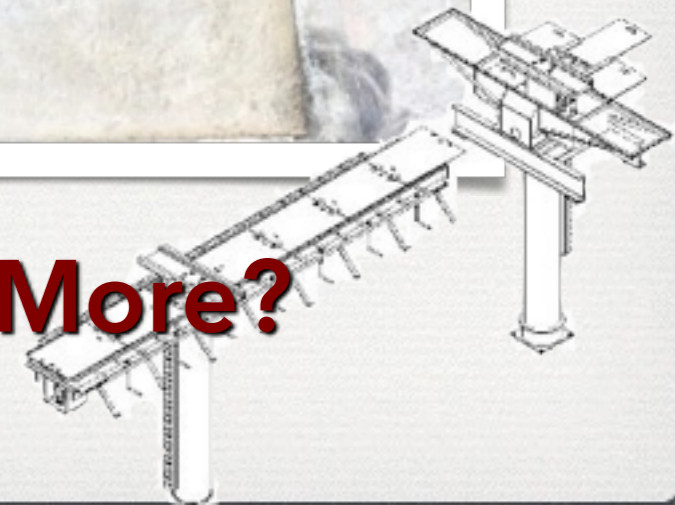



# Galvanized Sliding Plates



**Remember When Lifts Lasted 25 yrs. or More?**





## Specialty Frame Adapters



**Remember When Lifts Lasted 25 yrs. or More?**

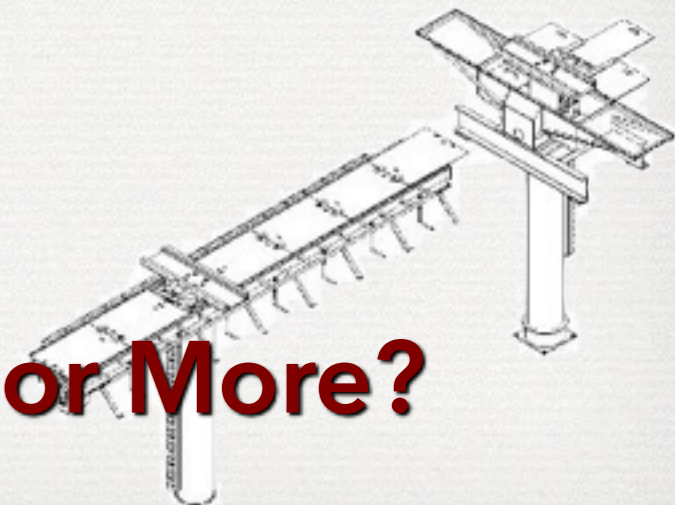





## Sliding Frame Adapter

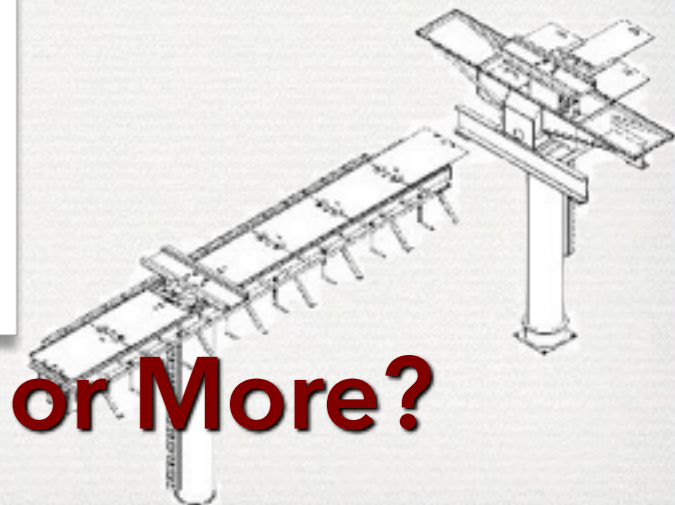

**Remember When Lifts Lasted 25 yrs. or More?**



## Heavy Duty Sliding Bolster

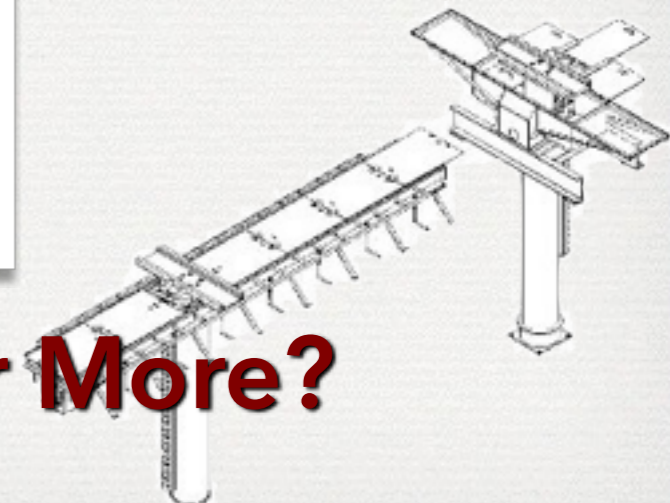

**Remember When Lifts Lasted 25 yrs. or More?**



## Installation of Galvanized Frame



**Remember When Lifts Lasted 25 yrs. or More?**

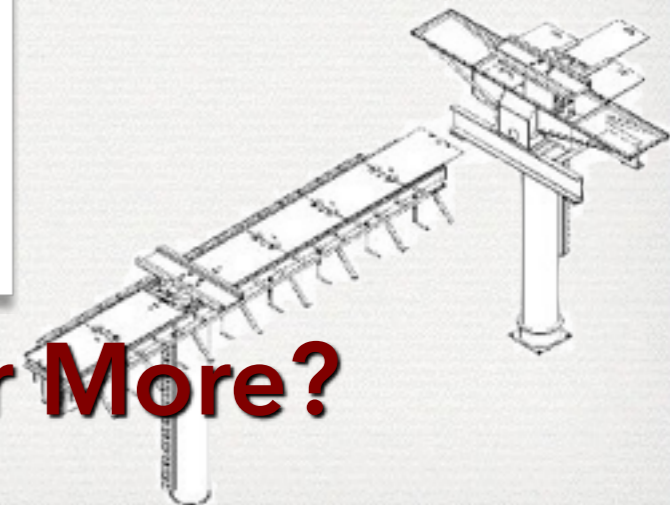



## Recessed Frame in Cement Vault

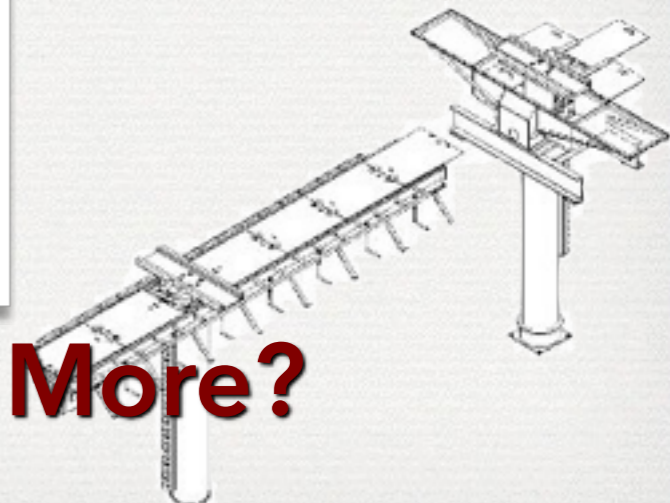

**Remember When Lifts Lasted 25 yrs. or More?**



# Drainage PVC Pipe Running To Grease Interceptor

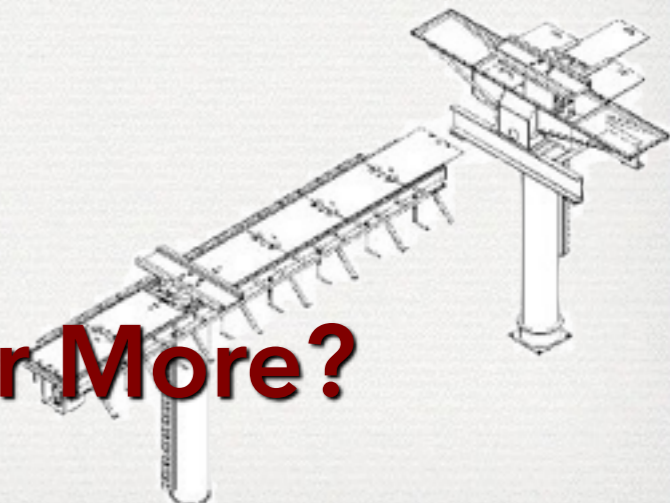

**Remember When Lifts Lasted 25 yrs. or More?**



## Precision In House Flame Cutting

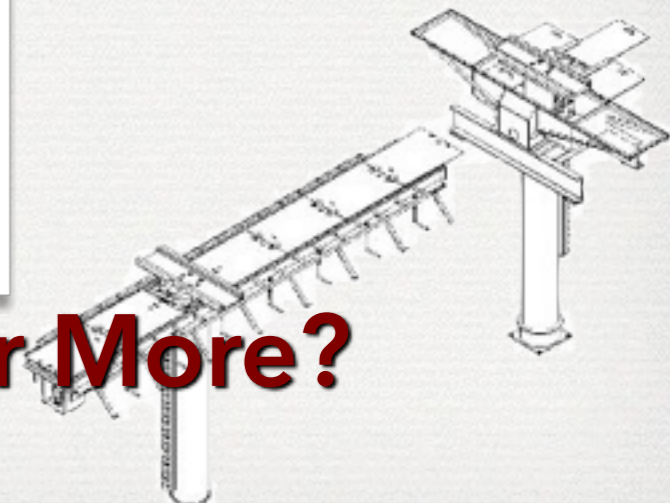

**Remember When Lifts Lasted 25 yrs. or More?**



## Casing Assembly Area



**Remember When Lifts Lasted 25 yrs. or More?**

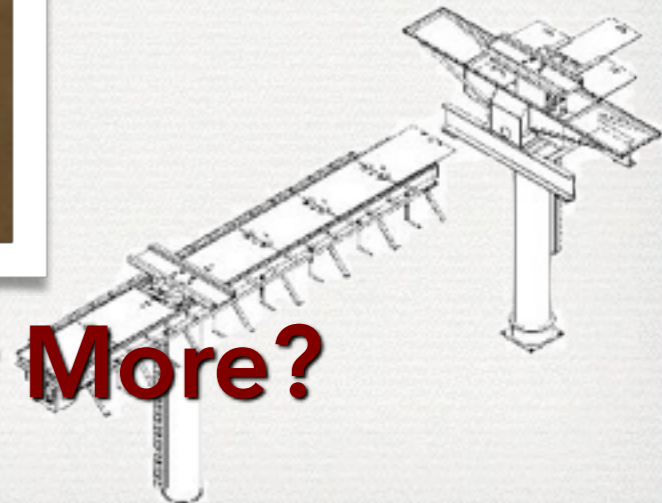



## In House Brake Press



**Remember When Lifts Lasted 25 yrs. or More?**

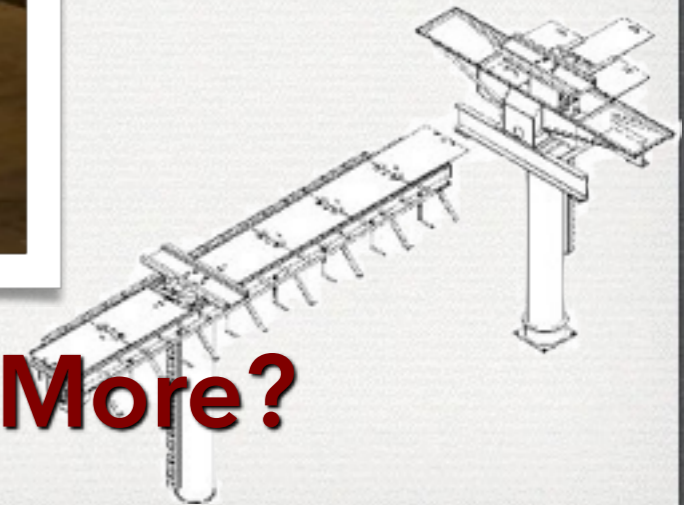





## On Hand Service Parts



**Remember When Lifts Lasted 25 yrs. or More?**

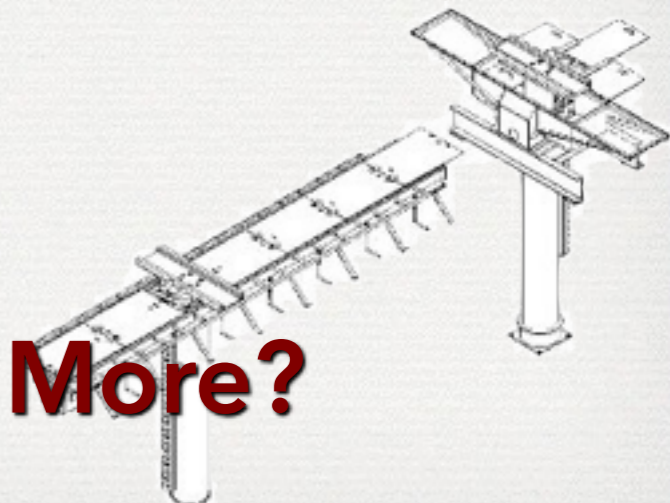



# Premium Welding - Bolster Plates QT-100 100,000 lb. Yield Steel

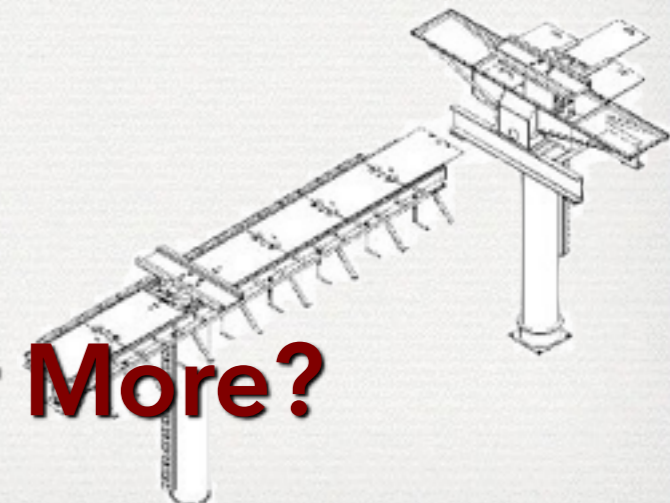

**Remember When Lifts Lasted 25 yrs. or More?**



# Precision Machining Plungers



**Remember When Lifts Lasted 25 yrs. or More?**

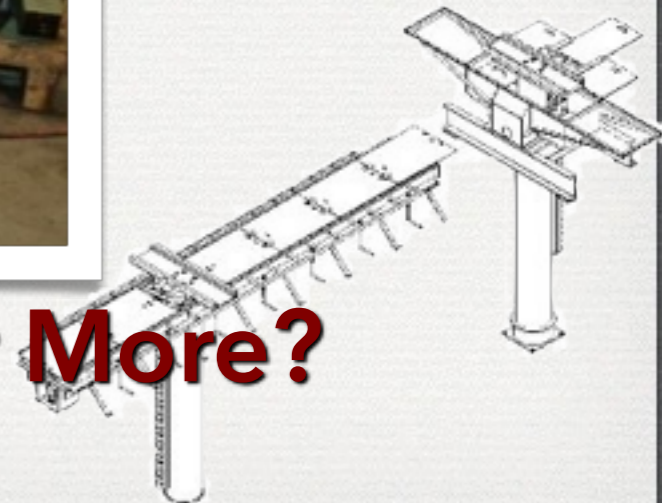



## C & C In House Lathe Operations



**Remember When Lifts Lasted 25 yrs. or More?**

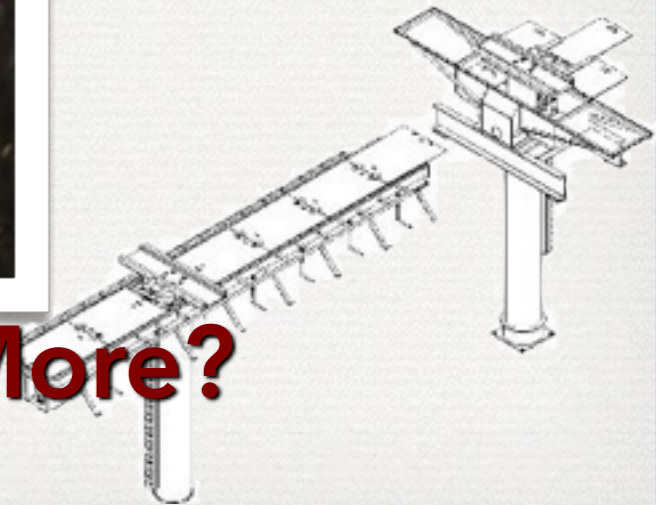



## Precision Machined Parts



**Remember When Lifts Lasted 25 yrs. or More?**

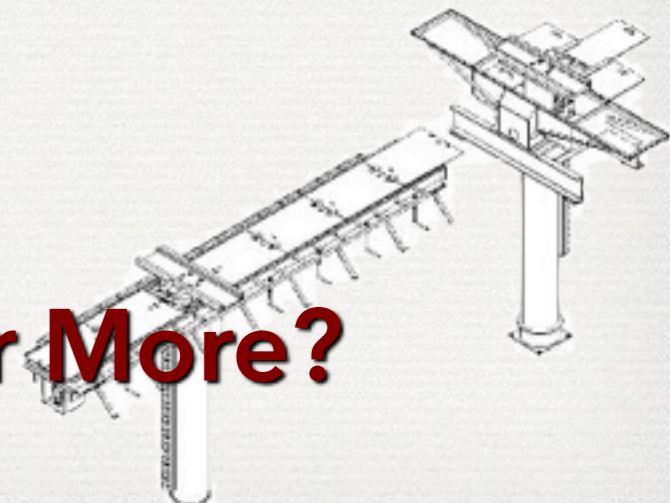



## In Stock 10" & 12" Cylinders



**Remember When Lifts Lasted 25 yrs. or More?**





## Recessed Rear Cylinder Box



**Remember When Lifts Lasted 25 yrs. or More?**

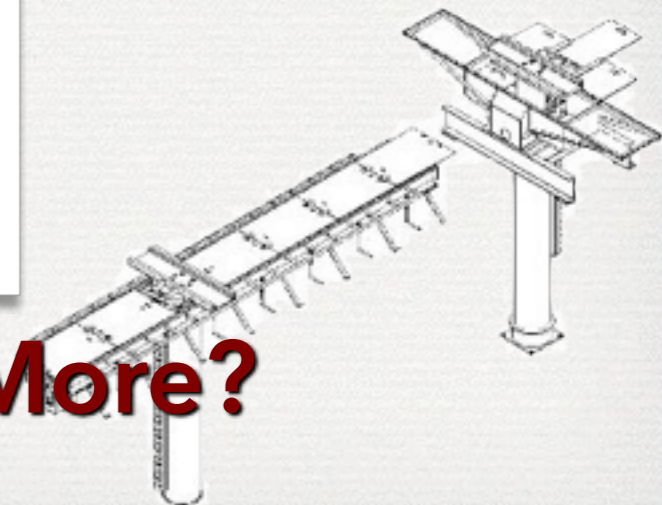



# Kop Coat Casing Protection

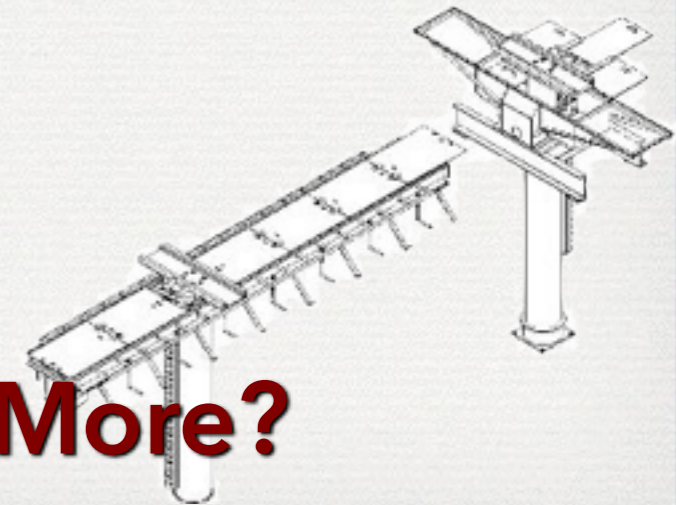
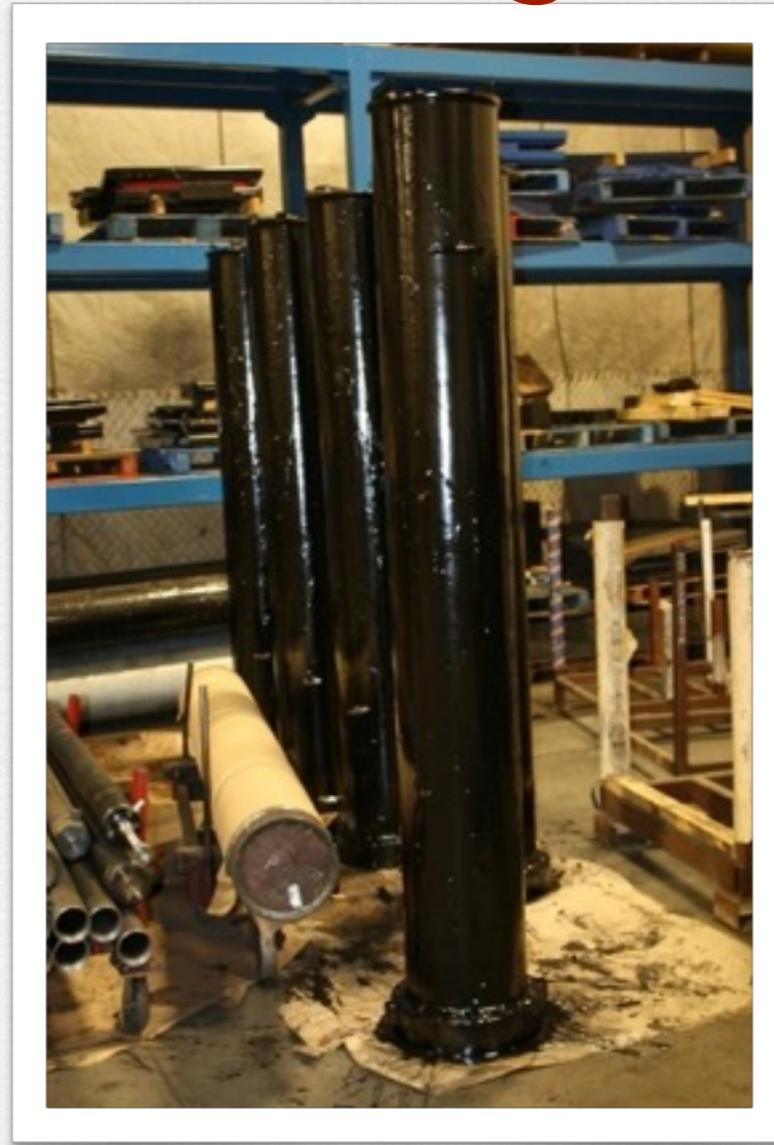

**Remember When Lifts Lasted 25 yrs. or More?**





# Optional Hot Dipped Galvanized Casings

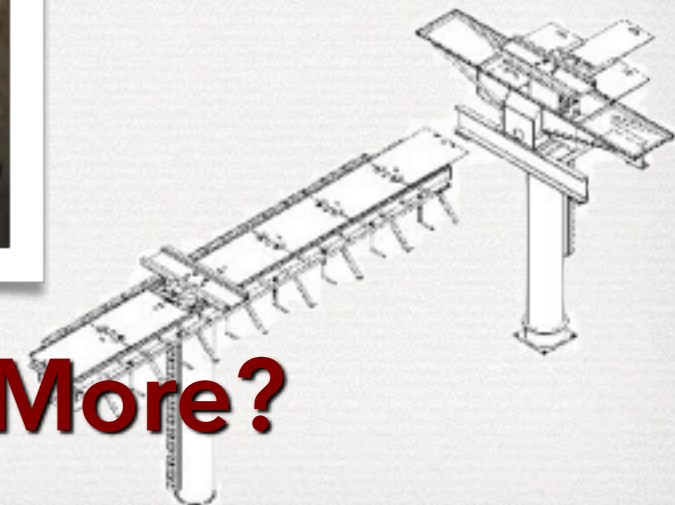
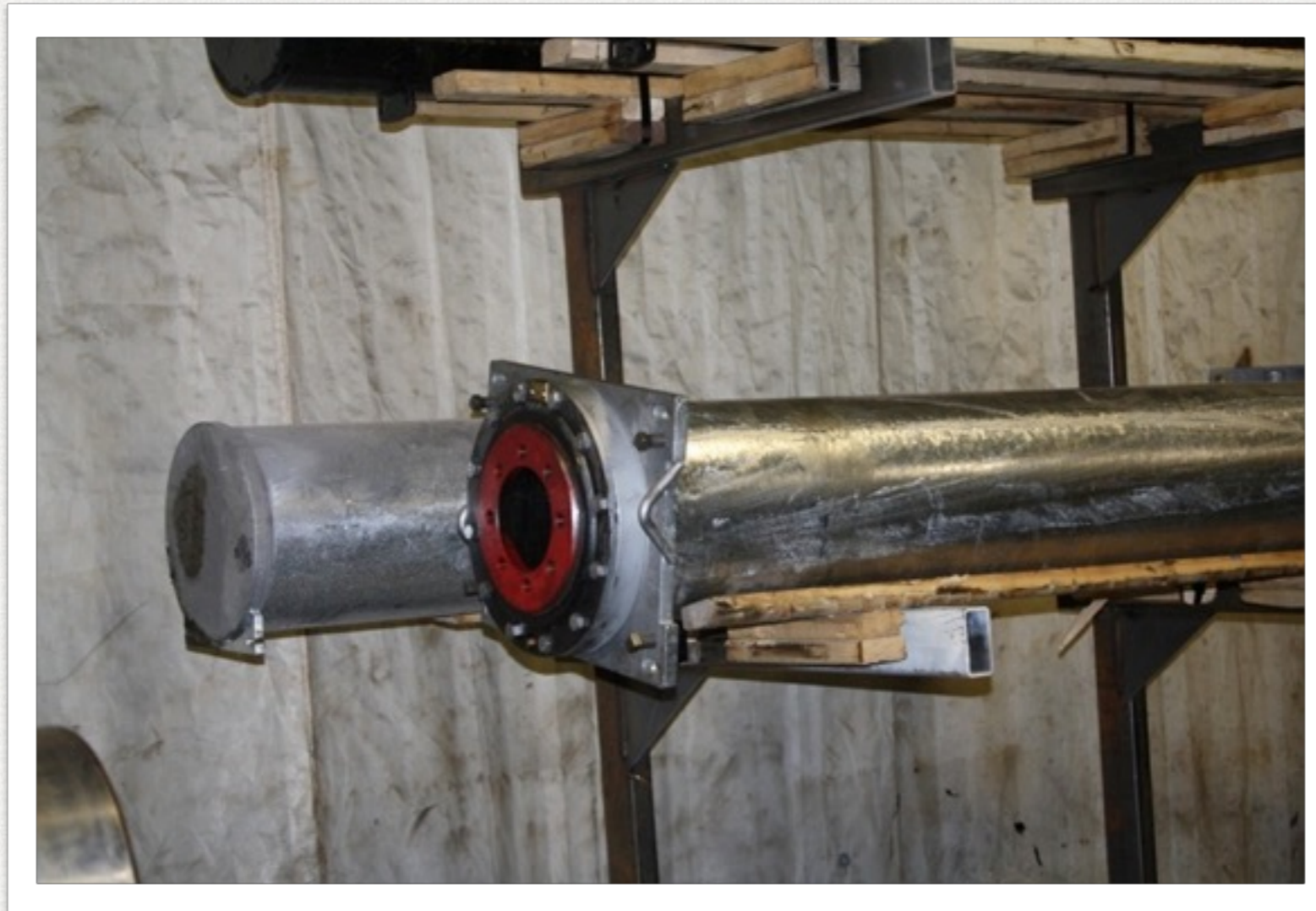

**Remember When Lifts Lasted 25 yrs. or More?**



## Upper Seal & Bearing Flange

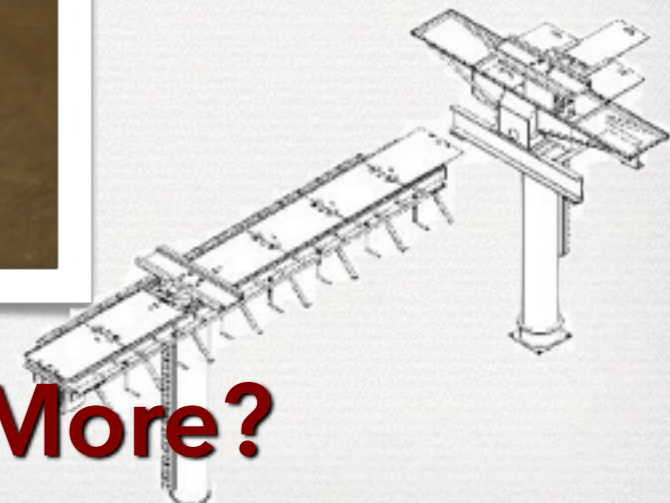

**Remember When Lifts Lasted 25 yrs. or More?**



## 3 Ram Lift with Equalized Power Unit

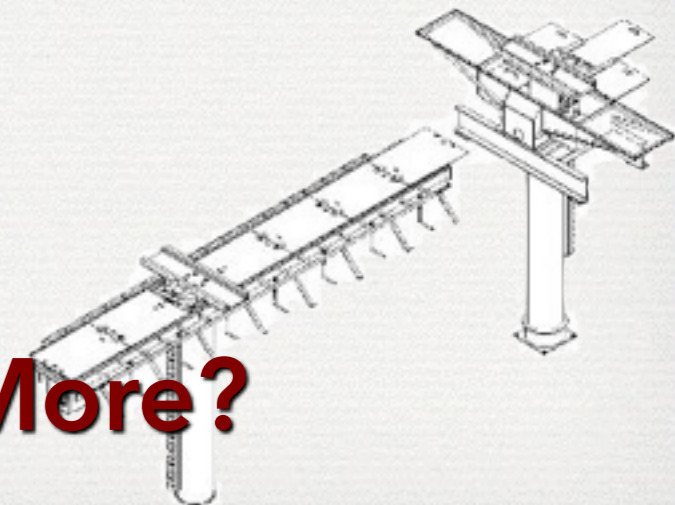
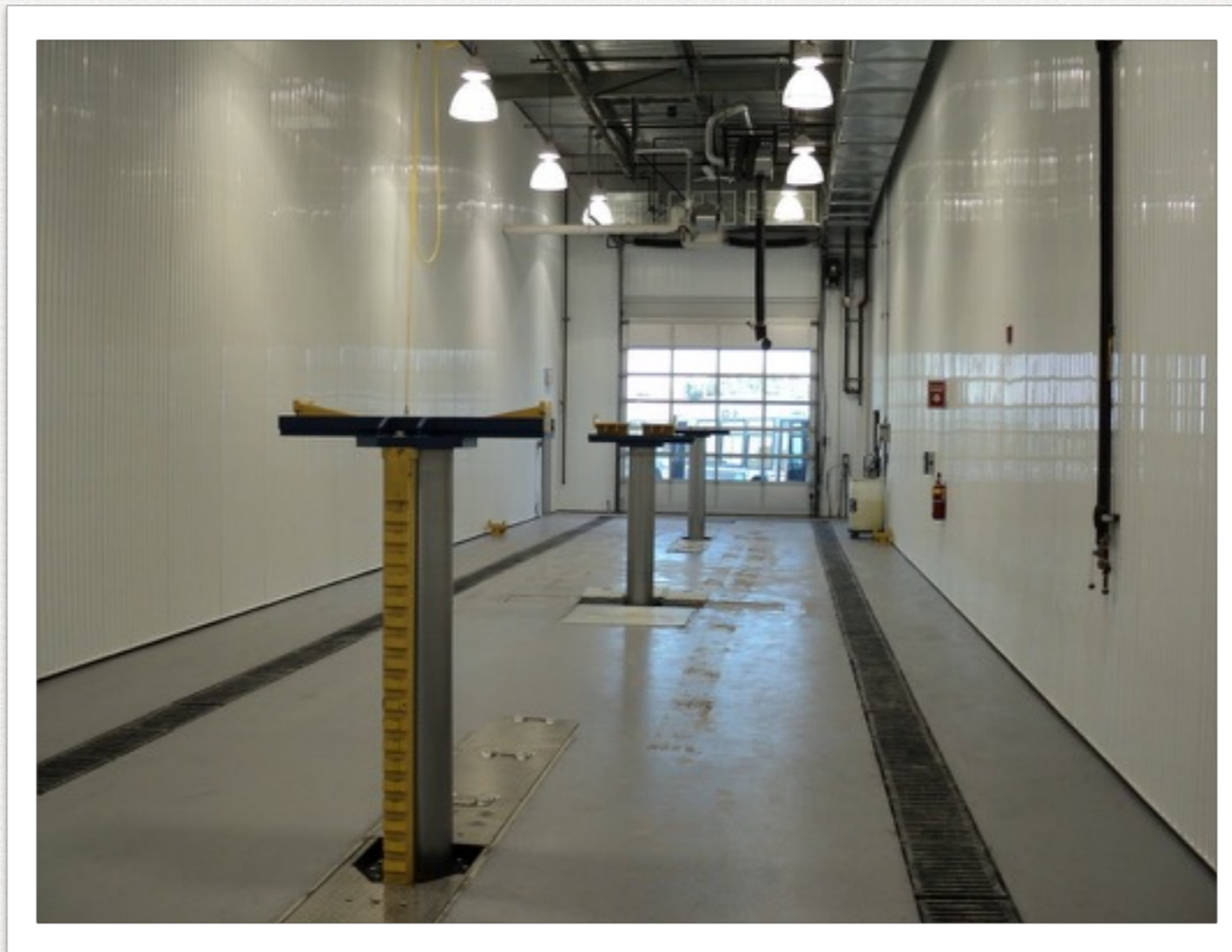

**Remember When Lifts Lasted 25 yrs. or More?**