

TLS 2 POST LIFT SYMMETRIC & ASYMMETRIC

10,000 lbs. Capacity



- 1 COMPACT DESIGN – RUGGED CONSTRUCTION**
Small foot print takes up less bay space while still allowing best in class weight capacities of 10,000lbs.
- 2 VERSATILITY AND EASE OF USE**
Ideal for small compact cars up to light duty trucks with pull out extensions allowing ease of use on short or long wheelbase vehicles
- 3 STAYS LEVEL ALL THE TIME**
Thanks to single cylinder with dual chamber unit stays level all the time.
- 4 LOWER MAINTINANCE – LESS DOWNTIME**
No Cables, No equalization valve, Extra-large pins with accessible grease fittings makes this ideal equipment for high duty cycle shops who require less downtime.
- 5 BUILT FOR SAFETY**
21 locking positions ensure side to side stability and eliminates accidental lowering of the lift.
- 6 UNOBSTRUCTED ACCESS**
Open front and rear construction with no tire bars or torsion rods allows for unobstructed access to the underside of most vehicles with 35" of working area between the superstructures.
- 7 EASY VEHICLE SPOTTING**
The flat deck platform and "spotting blocks" allows quick set-up by the operator increasing bay productivity.
- 8 LOW PROFILE APPROACH RAMPS OR FLUSH MOUNT OPTIONS**
The low profile ramp extensions allow for accessibility of smaller compact cars while still allowing for heavier loads. The lift can also be flush mounted for the ultimate in productivity and space saving bay solutions.

DOUBLE SCISSOR LIFT FEATURES	TLS10SSOR1 TLS10SSOR1FM
Double Bake Powder Coat Finish	yes
Low Approach Angle with 8.3" Lowered He (Surface Mount)	yes
Muti Position Locking Rack 21 Positions	yes
Grease Fitting at Every Hinge	yes
Premium North American Made Power Unit	yes
Air Regulator with Water Trap/Oiler	yes
Adjustable Lifting Platform up to 82"	yes
Raised Height of 72.5"	yes
Premium North American Made Power Unit	yes
Parts Warranty	1 year
Labor Warranty	1 year
Hydraulics Warranty	1 years
Structural Warranty	5 years
Accessory Warranty	90 days
Optional 3 Phase Power	yes
SPECIFICATIONS	TLS10SSOR1 TLS10SSOR1FM
Capacity	10,000 lbs
Overall Length - Surface Mount	160"
Overall Length - Flush Mount	60"
Overall Width	82"
Width Between Runways	35"
Deck Width	24"
Lowered Height	8.5"
Raised Height	80"
Lift Time	45 seconds
Power Requirements	230V - 60Hz - 1Ph - 20 Amp
Shipping Weight	5,860 lbs

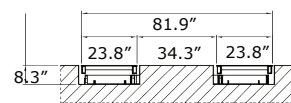
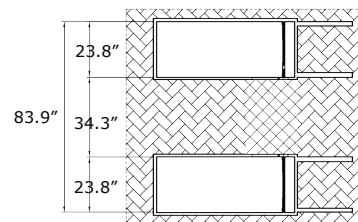
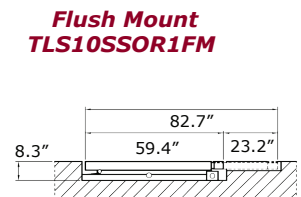
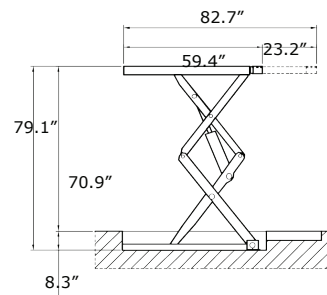
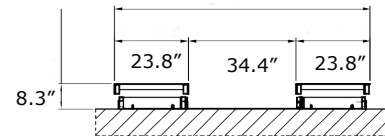
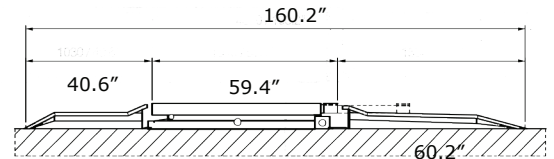
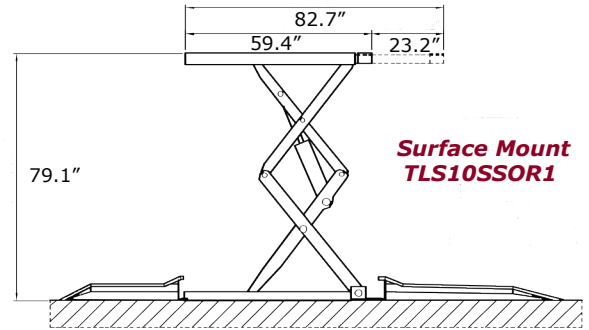

Total Automotive Lifting Solutions Inc.



2300 Speers Road, Oakville, Ontario
L6L 2X8 Ph. (877) 799-5438